

MITEL

5212 | 5224 | IP Phone

USER GUIDE

 MITEL | it's about **YOU**

SX-200 ICP 3.0

Contents

| | |
|--|----|
| ABOUT YOUR PHONE | 1 |
| Elements of Your Phone | 4 |
| Selecting Menu Options | 6 |
| About Feature Access Codes | 6 |
| 5224 IP PHONE AND LINE INTERFACE MODULE | 7 |
| TIPS FOR YOUR COMFORT AND SAFETY | 7 |
| Don't cradle the handset! | 7 |
| Protect your hearing | 7 |
| Important Note for Headset Users | 8 |
| Adjust the viewing angle | 8 |
| CUSTOMIZING YOUR 5212/5224 IP PHONE | 9 |
| Ringer Control | 9 |
| Handset Receiver Volume Control | 9 |
| Speaker Volume Control | 9 |
| Display Contrast Control | 9 |
| Feature Keys | 10 |
| Language Change | 10 |

| | |
|---------------------------------------|--------|
| MAKING AND ANSWERING CALLS | 11 |
| Make a Call - PBX | 11 |
| Make an External Call - KTS | 11 |
| Make an Intercom Call - KTS | 11 |
| Answer a Call | 12 |
| Redial | 12 |
| Speed Call Keys | 13 |
| Speed Call - Personal | 14 |
| Group Listen | 14 |
| Handsfree Operation | 15 |
| Auto-Answer | 16 |
| CALL HANDLING | 17 |
| Hold | 17 |
| Hold and Page | 17 |
| Mute | 18 |
| Handset Mute | 18 |
| Transfer | 18 |
| Conference | 19 |
| Conference Split (5224 IP Phone only) | 19 |
| Add Held (5224 IP Phone only) | 19 |
| Swap | 19 |
| Call Forward | 20 |
| Call Forward - I'm Here | 21 |
| Call Forward - Forced | 22 |
| Call Forward - Toggle | 22 |
| Messaging - Advisory | 23 |
| Messaging - Callback | 23 |

| | |
|---|-----------|
| USING ADVANCED FEATURES | 24 |
| Account Codes | 24 |
| Callback | 24 |
| Call Park | 25 |
| Call Park - System | 26 |
| Call Park - Specific Orbit | 27 |
| Call Park - Destination Phone | 28 |
| Call Pickup | 28 |
| Campon | 28 |
| Do Not Disturb | 29 |
| Override (Intrude) | 29 |
| Paging - PA | 29 |
| Paging - Direct | 30 |
| Handsfree Answerback to a Direct Page | 31 |
| Paging - All Sets | 34 |
| Paging - Group | 34 |
| Direct Station Select/Busy Lamp Field (DSS/BLF) | 34 |
| Direct Station Select (DSS)/Busy Lamp Field (BLF)/Call Pickup | 35 |
| Direct Page/Busy Lamp Field (BLF) | 35 |
| DSS/BLF/Direct Page/Call Pickup | 35 |
| Headset Operation | 36 |
| Headset Operation (Headset with Feature Control Switch) | 37 |
| Music | 38 |
| Park and Page | 39 |
| Record a Call | 41 |
| Auto-Latch Microphone | 42 |
| Reminder | 43 |
| Reminder - Multiple | 44 |
| Call Logging (5224 IP Phone only) | 46 |
| Phonebook | 47 |
| Call Monitoring | 48 |
| Door Opener | 49 |
| Night Answer | 50 |
| Date and Time Setup (5224 IP Phone only) | 51 |
| Release | 51 |
| Secure Hot Swap | 52 |
| Mobile Extension | 53 |

| | |
|---|----|
| USING THE LINE INTERFACE MODULE (5224 IP PHONE ONLY) | 53 |
| LINE INTERFACE MODULE MODE | 54 |
| FAILOVER MODE | 56 |
| EMERGENCY CALLS | 56 |
| FEATURE ACCESS CODES | 57 |

ABOUT YOUR PHONE

The Mitel Networks 5212 and 5224 IP Phones are full-feature, dual port, dual mode telephones that provide voice communication over an IP network. Each features a back-lit liquid crystal display (LCD) screen, display-assisted access to features, on-hook dialing and off-hook voice announce with handsfree answerback and a large ring/message indicator. The 5212 IP Phone offers 12 programmable keys, and the 5224 IP Phone offers 24 programmable keys for one-touch feature access. Both phones provide ten fixed feature keys for convenient access to features such as Conferencing, Redial, and many customizable user settings. The 5212 and 5224 IP Phones support the Mitel Call Control (MiNet) protocol and Session Initiated Protocol (SIP). The 5224 IP Phone also supports modules such as the Line Interface Module, 5310 IP Conference Unit, and the 12 and 48 Button Programmable Key Modules. The 5224 IP Phone can be used as an ACD Agent Phone or a Teleworker phone.

The personal key on the bottom right (5224) or bottom left (5212) is always your Prime Line; the remaining personal keys can be programmed as:

- Feature keys (for example, Swap). You can program feature keys from your phone. Your administrator can also program feature keys.
- Speed Call keys. You can program speed call keys from your phone.
- Line Appearances. Only the administrator can program line appearances.



NN0191





The 5212 IP Phone











NN0192

The 5224 IP Phone

Elements of Your Phone

| Feature | Function |
|-------------------------------------|--|
| 1 Display | Provides a two-line, 20-character liquid crystal display (LCD) viewing area that assists you in selecting and using phone features, accessing your voice mail, and identifying callers. When you are using the Superkey menu interface, prompts and feature information appear on the display screen. For information on selecting menu options with or without softkeys, see "Selecting Menu Options" elsewhere in this guide. |
| 2 Softkeys (5224 IP Phone only) | Context-sensitive keys change depending on the modes of the operation and the menu currently displayed. Softkeys enable you to easily view and select a variety of features. |
| 3 Ring/Message Indicator | Flashes to signal an incoming call and to indicate a message waiting in your voice mailbox. |
| 4 Volume, Speaker and Mute Controls | Provide the following audio control capability: <ul style="list-style-type: none">•  (UP) and  (DOWN) provide volume control for the ringer, handset, and handsfree speakers.•  (SPEAKER) enables and disables Handsfree mode.•  (MUTE) enables Mute, which allows you to temporarily turn your phone's handset or handsfree speaker microphone off during a call. |

| Feature | Function |
|---|---|
| 5 Fixed Function Keys | <p>Give you access to the following phone functions:</p> <ul style="list-style-type: none"> •  (SUPERKEY) : provides access to menus for your phone's additional features. Note : When navigating through Superkey menu options, press  (CANCEL) or  (SUPERKEY) to back up one menu level. •  (CANCEL) : ends a call when pressed during the call, and, when you are programming the phone, eliminates any input and returns to the previous menu level. •  (REDIAL) : calls the last number dialed. •  (HOLD) : places the current call on hold. •  (TRANS/CONF) : initiates a call transfer or establishes a three-party conference call. •  (MESSAGE) : provides access to your voice mailbox and flashes to notify you of messages waiting in your voice mailbox. Note : The Ring/Message indicator also flashes when messages are waiting. |
| 6 Keypad | Use to dial. |
| 7 Programmable Personal Keys and Designation Card | <p>Provides 12 keys that can be programmed as speed call keys, feature keys, or line appearance keys, according to your communication needs. Personal keys have status indicators. On a 5224 IP Phone, the bottom right personal key is always your Prime Line key. On the 5212 IP Phone, the bottom left personal keys is always your Prime Line key. The bottom left personal key is always your Prime Line key. Write the name (speed call, feature or line appearance) of the Personal keys that you program on the designation card (use the side of the card with the textboxes provided). Use the slot behind the plastic cover at the bottom of the phone to remove/insert the designation card.</p> |
| 8 Handsfree Speaker | Provides sound for Handsfree calls and background music. |
| 9 Handset | Use for handset calls. If you are in headset or handsfree mode, you do not need to use the handset. |

Ring/Message indicators

When indicator is

Flashing rapidly

Flashing slowly

On

Off

it means that

Your phone is ringing

A message or callback message is waiting at your phone

Your phone is ringing another phone

Your phone is idle, or you are on a call

Selecting Menu Options

Because the 5224 IP Phone offers softkeys, feature availability and menu options for the 5212 and 5224 IP Phones may differ.

To select menu items on the display:

1. On a 5224 IP Phone, press the softkeys.
2. On a 5212 IP Phone, press *, 0 and # on the keypad. For example, if options *=YES 0=DEFAULT #=NO appear and you want to select YES, press *.

Procedures in this guide show all menu selection options, when applicable—for example, "Press the * or **Yes** softkey". Procedures in this guide also specify when a menu option is available only on one of the phones—for example, "On a 5224 IP Phone only, press the **Save** softkey".

About Feature Access Codes

Use of some features requires dialing access codes. The codes are flexible and may be different than those in this guide. Ask your Administrator for a list of codes you should use.

5224 IP PHONE AND LINE INTERFACE MODULE

The Line Interface Module is an optional device that adds an analog phone line (POTS) capability to your 5224 IP Phone (only). If Emergency Call Routing is not programmed on your SX-200 ICP, you must use the Line Interface Module to dial emergency calls. For more information on emergency number dialing, refer to Emergency Calls.

If you have a Line Interface Module connected to your 5224 IP Phone, all programming of the Line Interface Module, except the Analog Key, is done by the Installer when your phone is installed. For more information, refer to "Using the Line Interface Module" elsewhere in this guide.

Note: The 5212 IP Phone does not support the Line Interface Module.

TIPS FOR YOUR COMFORT AND SAFETY

Don't cradle the handset!

Prolonged use of the handset can lead to neck, shoulder, or back discomfort, especially if you cradle the handset between your ear and shoulder. If you use your phone a lot, you may find it more comfortable to use a headset. See the section on headset usage elsewhere in this guide for more information.

Protect your hearing

Your phone has a control for adjusting the volume of the handset receiver or headset. Because continuous exposure to loud sounds can contribute to hearing loss, keep the volume at a moderate level.

Important Note for Headset Users

Mitel Networks Headsets with Feature Control Switch must be installed in the dedicated headset jack on the back of the phone. Installation will disable your handset microphone. Disconnecting the headset at the jack or at the quick-disconnect plug restores handset operation.

Adjust the viewing angle

The stand built into your phone tilts to give you a better view of the keys.

To tilt your telephone for better viewing:

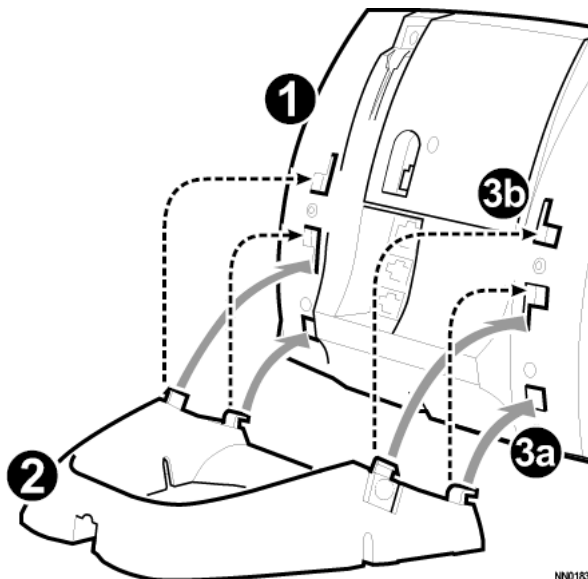

1. Turn the phone so that the front faces away from you.
2. Hold the base unit firmly and press the release tabs on the sides of the stand to detach the base unit.
3. Hinge the hooks of the base unit into the notches on the back of the phone and snap into place as follows:
 - a. For a high-angle mount, hinge the two lower hooks into the bottom set of notches and snap the two upper hooks into the middle set of notches.
 - b. For a low-angle mount, hinge the two lower hooks into the middle set of notches and snap the two upper hooks into the top set of notches.







CUSTOMIZING YOUR 5212/5224 IP PHONE

Ringer Control

To adjust the Ringer Volume while the set is ringing:



- Press  (UP) or  (DOWN).

To adjust the Ringer Pitch while the set is idle:

1. Press  (SUPERKEY).
2. Press # or the **No** softkey until "Ringer Adjust?" appears.
3. Press * or the **Yes** softkey twice.
4. Press  (UP) or  (DOWN).
5. On the 5212 IP Phone only, press #.
6. Press  (SUPERKEY).



Handset Receiver Volume Control

To adjust the Handset Receiver Volume when you are using the handset:

- Press  (UP) or  (DOWN).



Speaker Volume Control

To adjust the Speaker Volume when making an on-hook call or when listening to background music:

- Press  (UP) or  (DOWN).



Display Contrast Control

To adjust the Display Contrast while your set is idle:

- Press  (UP) or  (DOWN).

Feature Keys



To display information about a key:

1. Press  (**SUPERKEY**).
2. Press a personal key that isn't a line key.
3. Press  (**SUPERKEY**).

To program a feature key using a Feature Access Code:

1. Dial *47.
2. Press an unused personal key.
3. Dial the feature code for the desired feature key.
4. Press  (**CANCEL**).
5. Write the feature name on the key label.

To program a feature key using Superkey:

1. Press  (**SUPERKEY**).
2. Press # or the **No** softkey until "Personal Keys?" appears.
3. Press * or the **Yes** softkey.
4. Press a personal key that isn't a line key.
5. Press * or the **Change** softkey.
6. Press # or the **No** softkey until the desired feature appears.
7. Press * or the **Yes** softkey.
8. Press  (**SUPERKEY**), or press another personal key and proceed to program another feature.
9. Write the feature name on the key label.

Language Change

To change the display language:

1. Press  (**SUPERKEY**).
2. Press # or the **No** softkey until "Language?" appears.
3. Press * or the **Yes** softkey.
4. Press * or the **Change** softkey.
5. Press # or the **No** softkey until the desired language appears.
6. Press * or the **Yes** softkey.

MAKING AND ANSWERING CALLS

If your telephone system operates as a private branch exchange (PBX), the Prime Line can be used for both incoming and outgoing calls. Outgoing calls on a PBX system require dialing a line access code (usually 9) followed by the telephone number. In a key telephone system (KTS), the Prime Line is used for internal (Intercom) calls only. Outgoing calls require the use of Line keys.

Make a Call - PBX

1. Lift the handset.
2. Do one of the following:
 - Dial the extension number or a line access code (usually "9") and the telephone number for an outside call.
 - Press a Speed Call key.

Make an External Call - KTS

1. Lift the handset.
2. Press a Line key.
3. Do one of the following:
 - Dial the telephone number.
 - Press a Speed Call key.
 - Press  (REDIAL).

Make an Intercom Call - KTS



An Intercom call is a call between two extensions, which either pages or rings the called extension.

To switch between a ringing intercom call to a paged intercom call:

1. Make a call.
2. Do one of the following while listening to ringback tone:
 - Press the **Direct Page** feature key.
 - Dial ***48**.

Answer a Call

To answer a call, do one of the following:

- Lift the handset.
- Press  (**SPEAKER**).
- Press the flashing Line Appearance key and lift the handset.
- Press the flashing Line Appearance key and press  (**SPEAKER**).

Note: The Auto-Latch Microphone feature described elsewhere in this guide allows you to answer and respond to internal calls handsfree.

Redial

To redial the last number that you manually dialed:

1. Lift the handset.
2. Press  (**REDIAL**).





Speed Call Keys

You may use Speed Call Keys to make a call or to send a string of digits during a call (press a Speed Call Key during a call to send a multi-digit password, for instance).

To dial a stored Speed Call number:

1. Lift the handset.
2. Press a Speed Call key.

To store a Speed Call number:



1. Press  (**SUPERKEY**).
2. Press # or the **No** softkey until "Personal Keys?" appears.
3. Press * or the **Yes** softkey.
4. Press a personal key that isn't a line key.
5. Press * or the **Change** softkey.
6. On a 5224 IP Phone only, press the **Yes** softkey.
7. Do one of the following:
 - To store a new number, dial 9 or other digit(s) used to access an outside line (if required) then dial the telephone number.
Press  (**HOLD**) between digits to create a one-second pause during dialing *emdash; press  (**HOLD**) more than once to lengthen the pause.
 - To enter the last number dialed, press  (**REDIAL**).On a 5212 IP Phone only, press the personal key again.
8. Do one of the following:
 - If you want the number to be private, press the * or the **Priv** softkey.
 - If you want the number to be visible, press # or the **No** softkey or the **Save** softkey.
9. Press  (**SUPERKEY**).

Speed Call - Personal

To dial a stored personal Speed Call number:

1. Lift the handset.
2. Dial ***52**.
3. Enter an index number between **1** and **5**.

To store a personal Speed Call number:

1. Lift the handset.
2. Dial ***51**.
3. Enter an index number between **1** and **5**.
4. Dial "9" or other digit(s) used to access an outside line (if required) then dial the telephone number.
Press  **(HOLD)** between digits to create a one-second pause during dialing — press  **(HOLD)** more than once to lengthen the pause.
5. Hang up.

Group Listen

To allow others in the room to listen to the far end of a handset call:

- Press the Group Listen feature key.

To return to a private two-way handset call from Group Listen:

- Press the Group Listen feature key.

To change a Group Listen call into a Handsfree call so that allow others in the room can join the telephone conversation:

1. Press  **(SPEAKER)**.
2. Hang up the handset.

To return to a private two-way handset call from Speaker:

- Lift the handset.

Handsfree Operation

To use Handsfree Operation to make calls:

1. If you want to use a Non-Prime Line, press a Line Appearance key.
Note: Your administrator must program Line Appearances to your phone.
2. Dial the number.
3. Begin speaking when the called party answers. Your phone's Handsfree microphone and Handsfree speaker transmit and receive audio.

To use Handsfree Operation to answer calls:

1. Press the flashing line key.
2. Begin speaking. Your phone's Handsfree microphone and Handsfree speaker transmit and receive audio.

To hang up while using Handsfree Operation:

- Press  (**SPEAKER**).

To temporarily mute the microphone during a Handsfree conversation:

- Press  (**MUTE**). The  (**MUTE**) key light turns on.

To turn mute off and return to the conversation:

- Press  (**MUTE**). The  (**MUTE**) key light turns off.

To disable Handsfree Operation:

- Lift the handset.

To return to Handsfree Operation:

1. Press  (**SPEAKER**).
2. Hang up the handset.

Auto-Answer

To enable or disable Auto-Answer when you are using a headset:

- Press the **Auto-Answer** feature key **Note:** When Auto-Answer is enabled, the  (**MUTE**) key light flashes rapidly to notify you of an incoming handsfree call.

To enable or disable Auto-Answer on a 5224 IP Phone only:

1. Press  (**SUPERKEY**).
2. Press the **No** softkey until "Auto Answer?" appears.
3. Do one of the following:
 - To enable Auto-Answer, press the **TurnOn** softkey.
 - To disable Auto-Answer, press the **TurnOff** softkey.

Note: When Auto-Answer is enabled, the  (**MUTE**) key light flashes rapidly to notify you when an incoming handsfree call has been established.



To answer a call when you hear ringback:

- Begin speaking. Your phone's Handsfree microphone and Handsfree speaker transmit and receive audio. Your phone's  (**MUTE**) key light flashes rapidly to indicate that the Handsfree microphone is on and the calling party can hear you.

To temporarily mute the Handsfree microphone:

- Press  (**MUTE**). The  (**MUTE**) key light turns ON solid.

To turn Mute off and return to the conversation:

- Press  (**MUTE**). The  (**MUTE**) key light turns OFF.

To end a call, do one of the following:

- Press  (**CANCEL**).
- Wait for the caller to hang up.

CALL HANDLING

Hold

To place a call on Hold:

- Press  (HOLD).

To retrieve a call from Hold:

1. Lift the handset.
2. Press the flashing line key.

To retrieve a call from Hold at another phone, do one of the following:

1. Press the flashing line key.
2. Dial *23 and the number of the phone that placed the call on hold.

Hold and Page

The Hold and Page feature allows you to put a call on hold and page without having to use a feature key or code. You can also page after parking a call; see Call Park - Specific Orbit.

To place a call on hold and page:

1. Press the red  (HOLD) key twice.
2. Make the page.

To place a call on hold and not page:

- Press the red  (HOLD) key.

Mute

Mute lets you temporarily turn your phone's handsfree speaker microphone off during a call. You can also mute your handset microphone—see the **Handset Mute** feature description elsewhere in this guide.

To turn Mute on during a call:

- Press  (**MUTE**). The  (**MUTE**) light turns ON.

To turn Mute off and return to the conversation:

- Press  (**MUTE**). The  (**MUTE**) turns OFF.

Handset Mute

To mute your handset's microphone during a call:



- Press the **Handset Mute** feature key.

To restore handset microphone operation:

- Press the **Handset Mute** feature key again.

Transfer

To Transfer an active call:



1. Press  (**TRANS/CONF**).
2. Dial the number of the third party.
3. Do one of the following:
 - To complete the Transfer, hang up.
 - To announce the Transfer, wait for an answer, consult, and hang up.
 - To cancel the Transfer, press  (**CANCEL**).

To transfer an active call during headset operation:

1. Press  (**TRANS/CONF**).
2. Dial the number of the third party.
3. To complete the Transfer, press the **Release** feature key.

Conference

To form a Conference when a two-party call is already in place, or to add another party to an existing Conference:

1. Press  **(TRANS/CONF)**.
2. Dial the number of the next party
3. Wait for an answer.
4. Press  **(TRANS/CONF)**.

To leave a Conference:

- Hang up or press  **(CANCEL)**.

Conference Split (5224 IP Phone only)

To Split a Conference and speak privately with the original party:

- Press the **Split** softkey.

Add Held (5224 IP Phone only)

To move a call on hold to another line appearance:

1. Press an available line key.
2. Press the **AddHeld** softkey.
3. Press the flashing line key.

To add a call on Hold to an existing conversation or conference:

1. Press the **AddHeld** softkey.
2. Press the flashing line key.

Swap

To call another party when you are in an established two-party call:

1. Press  **(TRANS/CONF)**.
2. Dial the number.

To alternate between the two parties:

- Press **Swap/Trade** feature key or the **Trade** softkey.



Call Forward

Call Forward lets you redirect incoming calls to an alternate number. "External Calls?" redirects your incoming external calls only; "Internal Calls?" redirects your incoming internal calls only. If you want to redirect both external and internal calls, you must program each separately.



"Always?" redirects all incoming calls regardless of the state of your telephone. "No Ans?" redirects calls after several rings if you don't answer. "If Busy?" redirects calls when your telephone is busy. "Busy/No Ans?" redirects calls when your telephone is busy or when you don't answer.

Note: For information about "I'm Here?", see Call Forward - I'm Here.

To program Call Forward:



1. Press  (**SUPERKEY**).
2. Press # or the **No** softkey until "Call Forwarding?" appears.
3. Press * or the **Yes** softkey .
4. Press # or the **No** softkey or the **Next** softkey until the desired call forwarding type appears.
An asterisk next to the Call Forward option indicates that call forwarding is turned on.
5. If a number is already programmed, press * or the **Change** softkey.
6. Press * or the **Program** softkey.
7. Dial the destination number.
If you make an error while dialing, press #.
8. Press  or the **Save** softkey to save.
9. Press  (**SUPERKEY**) to exit.

To turn Call Forward on and off (once it has been programmed):

1. Press  (**SUPERKEY**).
2. Press # or the **No** softkey until "Call Forwarding?" appears.
3. Press * or the **Yes** softkey.
4. Press # or the **No** softkey or the **Next** softkey until the desired call forwarding option appears.
5. Do one of the following:
 - On a 5212 IP Phone, press *.
 - On a 5224 IP Phone, press the **Change** softkey, and then the **TurnOff** or **TurnOn** softkey. To turn off call forwarding and delete the destination number, press the **Del** softkey.
6. Press  (**SUPERKEY**) to exit.

Call Forward - I'm Here

To forward calls from a remote station to your current location:

1. Press  (**SUPERKEY**).
2. Press # or the **No** softkey until "Call Forwarding?" appears.
3. Press * or the **Yes** softkey .
4. Press # or the **No/Next** softkey until "I'm Here?" appears.
5. Press * or the **Yes** softkey .
6. Dial the extension number of the remote station.
If you make an error while dialing, press # or the **No** softkey or the <— softkey.
7. Press  or the **Save** softkey.

To cancel Call Forward - I'm Here from the station that set it:

1. Lift the handset.
2. Dial *07.
3. Dial the extension of the remote station.
4. Hang up.

To cancel Call Forward - I'm Here from the phone that was forwarded:

1. Press  (**SUPERKEY**).
2. Press # or the **No** softkey until "Call Forwarding?" appears.
3. Press * or the **Yes** softkey .
4. When "Always?"* appears, press * or the **Change** softkey, then press # or the **Del** softkey .

Call Forward - Forced

To force an incoming call to be forwarded:

- Press the **Forward Call** feature key or the **Forward** softkey.

To immediately transfer to another extension's No Answer forwarding destination when making a call:

- Press the **Forward Call** feature key when it lights.

Call Forward - Toggle

This feature is useful if you want call forwarding in effect for Busy and No Answer conditions most of the time, but need to override it with Call Forward Always occasionally — for example, when you're using a second phone such as a SUPERSET 4090 cordless phone. Instead of changing the call forward programming on your main phone to turn Call Forward Always on and off, you can program a key to do it.

You can also program keys to turn Call Forward Busy, No Answer or Busy/No Answer on and off.

To toggle call forward:



- Press the programmed feature key: **Forward Always**, **Forward Busy**, **Forward No Ans**, or **Forward Busy/NA**.

For information on programming a feature key, see "Feature Keys" elsewhere in this guide.



Note: You may also program a **Forward All** key to enable and disable all call forward types that have a destination programmed.

Messaging - Advisory

To turn Messaging - Advisory on:

1. Press  (**SUPERKEY**).
2. Press # or the **No** softkey until "Advisory Msgs?" appears.
3. Press * or the **Yes** softkey.
4. Press # or the **Next** softkey until the desired message appears.
5. Press * or the **TurnOn** softkey.
6. Press  (**SUPERKEY**) to exit.

To turn Messaging - Advisory off:

1. Press  (**SUPERKEY**).
2. Press # or the **No** softkey until "Advisory Msgs?" appears.
3. Press * or the **Yes** softkey.
4. Press * or the **TurnOff** softkey.
5. Press  (**SUPERKEY**) to exit.

Messaging - Callback



To leave a Callback Message on a telephone when you hear busy or ringback tone:

- Press  (**MESSAGE**).

To respond immediately to a Message Waiting condition on your telephone:

1. Lift the handset.
2. Press  (**MESSAGE**). A call is placed to the message sender (voice mail system or extension user) that left the oldest message.

To view information about the messages before responding:

1. Press  (**MESSAGE**).
2. Do one of the following.
 - To call the message sender, press # or the **Call** softkey.
 - To delete the message, press * or the **Erase** softkey .
 - On a 5224 IP Phone only, to view additional caller details (if available), press the **More** and **Again** softkeys.
 - To view the next message, press .
 - Press  (**SUPERKEY**) to exit.

USING ADVANCED FEATURES

Account Codes

To enter an Account Code at the start of a call:

1. Press the **Account Code** feature key.
2. Enter the account code.
3. Dial the telephone number.

To enter an Account Code during a call on a 5224 IP Phone (only):

1. Press  (**SUPERKEY**).
2. Press the **No** softkey until "Account Code?" appears.
3. Press the **Yes** softkey.
4. Dial the Account Code digits.
5. Press the **Save** softkey.

Callback

To request a Callback when you reach a busy or unanswered telephone:

- Press the **Callback** feature key.

To answer a Callback:

- Lift the handset.

Call Park

To park a call that is on your prime line (Line 1 key), do one of the following:

- Press the **Call Park** feature key.
-OR-
Press **TRANS/CONF** and then dial ***33**.

The call is parked and you receive dial tone on your prime line.

To retrieve a parked call from your phone while your phone is idle, or while you are off-hook and hearing dial tone, do one of the following:

- Press the **Call Park** feature key.
-OR-
Dial ***22**.

To retrieve a parked call while you are on a call on your prime line, do one of the following:

- Press the **Call Park** feature key.
-OR-
Press **TRANS/CONF** and then dial ***22**.
You are connected to the parked call and the caller that was on your prime line is parked.

You are connected to the parked call and the caller that was on your prime line is parked.

To retrieve a parked call from another phone:

1. Lift the handset.
2. Dial ***23**.
3. Dial the prime line number (extension number) of the phone that parked the call.

Note: If the phone has both a parked call and a call on hold, dialing the Remote Hold Retrieve access code will retrieve the parked call.

Call Park - System

This feature allows you to park a call from any line on your telephone not just the prime line. The number of calls you can park is limited only by the number available system park "orbits."

To park a call in system orbit:

1. Press the lit **System Park** feature key.
2. Do either of the following:
 - Hang up
 - Press a line key to answer a call, retrieve a call or hold, or get dial tone.

To return to the caller if all the system orbits are busy:

- Press **ⓧ (CANCEL)** to return to the caller.

To retrieve a call parked on a system orbit from any extension:

- While listening to dial tone, dial ***57** followed by the park orbit number.

Call Park - Specific Orbit

This feature allows you to park a call in a specific orbit by entering a two-digit orbit number or by pressing a feature key assigned to a specific orbit number.

To park a call in a specific orbit:

1. Press the **System Park** feature key.
2. Enter a two-digit Orbit Number (01-25).
If the selected orbit already has a parked call, press **⊗ (CANCEL)** to return to the caller, and then repeat steps 1 and 2 but select a different orbit.

To retrieve a call parked in a specific orbit:

- While listening to dial tone, dial ***57** followed by the park orbit number.

To park a call in a specific orbit using an Orbit # feature key:

- Press a free (unlit) **Orbit #** feature key. (See "Feature Key" for instructions on programming a feature key.)

Once a call is parked, you can press the same **Orbit #** to initiate a page.

To retrieve a call parked using an Orbit # feature key:

- Press the flashing **Orbit #** feature key.

Call Park - Destination Phone

Call Park - Destination Phone allows you to park an answered call on another phone. If a parked call is not retrieved after a specified length of time, a reminder occurs.

To park an active call on another phone:

1. Press  (TRANS/CONF) to get dial tone.
2. Dial *62, and then dial the extension of the destination phone.
If the call is parked successfully, dial tone, busy tone or a page occurs. If the call is not parked, reorder tone occurs.

To retrieve a call parked on another phone:

- Do one of the following:
 - Press the flashing **Call Park** feature key.
 - Dial *22.

Call Pickup

To answer a call that is ringing at another station in your Pickup Group:

1. Lift the handset.
2. Press the **Pickup** feature key.

To answer a call that is ringing at a station not in your Pickup Group:

1. Lift the handset.
2. Dial *09.
3. Dial the number of the ringing station.

Campon

To campon to a busy station:

- Press the **Campon** feature key or the **Wait** softkey.

To retrieve a call when you hear Campon tone:

- Press the **Swap/Trade** feature key or the **Trade** softkey .

Do Not Disturb

To activate and deactivate Do Not Disturb:

- Press the **Do Not Disturb** feature key. The key flashes to indicate that Do Not Disturb is active.

Override (Intrude)

To use Override when you encounter busy or DND tone:

- Press the **Intrude** feature key.

Paging - PA

To use Paging:

1. Lift the handset.
2. Do one of the following:
 - To page the default zone, press the **PA Page** feature key.
 - To page a specific zone, dial ***13** followed by the zone number (0-9).
3. Make the announcement.

Paging - Direct

Direct Paging allows you to page a party through their telephone speaker. If the paged party has Auto-Latch Microphone enabled, the page can be heard even when the party is on a handset or headset call. If the paged party has Handsfree Answerback enabled, your page automatically establishes a handsfree call with the paged party.

To page a party:

1. Lift the handset.
2. Press the **Direct Page** feature key or dial ***48**.
3. Dial the extension number.
4. Page the called party.

Note: If the phone you are paging has the "Can Be Paged" feature turned off, you hear a busy tone and the direct page cannot be connected.

How you answer a Direct Page depends on whether you have Handsfree Answerback to a Direct Page enabled on your phone. See "Handsfree Answerback to a Direct Page" elsewhere in this guide.

Note: You can also answer and respond to a Direct Page by enabling the Auto-Latch Microphone feature described elsewhere in this guide.

To allow or disallow Direct Pages to your phone:

1. Press  (**SUPERKEY**).
2. Press **#** or the **No** softkey until "Can Be Paged?" appears.
3. Do one of the following:
 - Press ***** or the **TurnOff** softkey if you want to receive Direct Pages.
 - Press **#** or the **TurnOn** softkey if you want to receive Direct Pages.

Handsfree Answerback to a Direct Page

When you receive a Direct Page, Handsfree Answerback automatically establishes a Handsfree call on your phone. Your administrator enables or disables Handsfree Answerback on your phone. After your administrator enables Handsfree Answerback, you can choose to turn it on or off directly from your phone.

Note: By default, Handsfree Answerback is OFF at your phone. If the  (**MUTE**) key light is OFF when your set is idle, Handsfree Answerback is OFF.

To turn Handsfree Answerback on:

- When your phone is idle, press  (**MUTE**) once. The MUTE key light flashes slowly to indicate that Handsfree Answerback is ON.
- When a Direct Page arrives, the MUTE key light flashes rapidly and a Handsfree call is automatically established.

To turn Handsfree Answerback off:

- Press the flashing  (**MUTE**) key once. The MUTE key light turns OFF. You will still receive Direct Page calls, but a Handsfree call is not automatically established.

To answer a call when Handsfree Answerback is ON, refer to the following table:

| Phone state before Direct Page arrives | To answer the Direct Page |
|--|---|
| Phone is idle, and MUTE is flashing slowly | <ol style="list-style-type: none">1. Check that MUTE is flashing rapidly.2. Listen for the paging party.3. Begin speaking.4. Lift the handset if you wish to switch from a Handsfree call to a handset call. |
| You are on a handset call, and MUTE is flashing slowly | <ol style="list-style-type: none">1. Check that MUTE is ON solid.2. Press MUTE. The light turns OFF and the Handsfree microphone turns ON.3. Speak to the paging party. <p>Note: Your handset microphone is still enabled.</p> |
| You are on a muted handset call, OR you are on a Handsfree call | The party paging you receives a busy tone. Handsfree Answerback does not interrupt your call. |

To answer a Direct Page when Handsfree Answerback is OFF, refer to the following table:

| | |
|---|--|
| Phone state before Direct Page arrives | To answer the Direct Page (indicated by a single burst of tone) |
|---|--|

Phone is idle, or you are on a handset call, and MUTE is OFF



1. Check that MUTE is ON solid.
2. Lift the handset **OR** press MUTE key to answer in Handsfree mode. (The light turns OFF.)
3. Begin speaking.

Note: If you were on a handset call, your handset microphone is still enabled.

You are on a MUTED handset call, OR, you are on a Handsfree call

The party paging you receives a busy tone. Handsfree Answerback does not interrupt your call.

To end a Handsfree Answerback call, do one of the following:

- Hang up the handset to end a handset call.
- Press  (**SPEAKER**) to end a handsfree call.
- Press  (**CANCEL**).

Note: When the Handsfree Direct Page call ends, the MUTE key light returns to the state it was in before the call was established.

Paging - All Sets

To page all telephones simultaneously through their speakers:

1. Lift the handset.
2. Press the **Direct Page** feature key.
3. Press *.
4. Page the called party.

To answer an All Set Page:

1. Lift the handset.
2. Dial *49.

Paging - Group

To page all telephones in a paging group simultaneously through their speakers:

1. Lift the handset.
2. Press the **Direct Page** feature key.
3. Press # or the **No** softkey.
4. Page the called parties.

To respond to a Group Page:

1. Lift the handset.
2. Dial *49.

Direct Station Select/Busy Lamp Field (DSS/BLF)

Your phone may have keys programmed to place calls to other extensions and to show the status (idle, busy or DND) of those extensions.

To call the DSS/BLF extension:

- Press the **DSS/BLF** key.

To transfer a call to DSS/BLF extension (without Secretarial option):

1. Press **TRANS/CONF**.
2. Press the **DSS/BLF** key.

To transfer a call to a station (with Secretarial option):

- Press the  **(TRANS/CONF)**.

Direct Station Select (DSS)/Busy Lamp Field (BLF)/Call Pickup

Your phone may have keys programmed to show the status (idle, busy, ringing, call on hold) of another destination and to retrieve calls ringing or on hold at the destination.

To retrieve a call ringing at the DSS/BLF destination:

- Press the slowly flashing **DSS/BLF** key.

To retrieve a call on hold at the DSS/BLF destination:

- Press the rapidly flashing **DSS/BLF** key.

Direct Page/Busy Lamp Field (BLF)

Your phone may have keys programmed to show the busy/idle status of another extension and to page the extension.

To page a DP/BLF extension:

- Press the **DP/BLF** key.

You can page when the DP/BLF extension is idle (key dark) or busy (key steadily lit).

DSS/BLF/Direct Page/Call Pickup

Your phone may have keys that show the status (idle, busy, ringing, or call on hold) of another extension. Depending on the programming of the key, pressing it will either call the extension if it is idle, or retrieve a call ringing or on hold at the extension, or page the extension.

To pick up a call ringing at the DSS/BLF extension:

- Press the slowly flashing **DSS/BLF** key.

To retrieve a call on hold at the DSS/BLF extension:

- Press the rapidly flashing **DSS/BLF** key.

To page a DSS/BLF extension:

- Press the dark or steadily lit **DSS/BLF** key.

Headset Operation

To use a headset with your phone, ensure that the headset is connected to the dedicated jack on the back of the phone.

To enable Headset Operation on telephones that are not programmed for full-time headset mode:

- Press the Headset feature key.

To answer a call (when Auto-Answer is disabled):

- Press the flashing line key.



To switch between headset and handset operation while in a call (see Note 2):

- Press  (**MUTE**). (You can talk using the **headset** when the MUTE key IS lit and with the **handset** when the MUTE key is NOT lit.

To hang up:

- Press  (**CANCEL**).

Notes:

1. Lifting the handset on some 5224 IP phones while it is in headset mode also answers the call.
2. This feature is available on some versions of the 5224 IP phone only.
3. Disconnecting the headset while in a call puts your phone in speaker-phone, mute mode. You can hear the other party but they cannot hear you. To talk to the other party, press  (**MUTE**). To hang up, press  (**SPEAKER**).

Headset Operation (Headset with Feature Control Switch)

IMPORTANT NOTE: Headsets with a feature control switch that are approved for use with the 5224 IP phone must be installed in the dedicated headset jack on the back of the phone. Installation will disable your handset microphone. Disconnecting the headset at the jack or at the quick-disconnect plug restores handset operation. If handset operation is required for an extended period of time, you should press the Headset feature key to return the telephone to handset mode.

To answer a call, do one of the following:

- Press the flashing Line Appearance key
- Quickly press and release the headset's feature control switch.
- Lift the handset (see Note 1).

To mute the headset microphone:

- Press and hold the headset's feature control switch.



To hang up:

- Press **CANCEL**.
- OR-
- Quickly press and release the headset's feature control switch.

To switch between headset and handset operation while in a call (see Note 2):



- Press  (**MUTE**). (You can talk using the **headset** when the MUTE key IS lit and with the **handset** when the MUTE key is NOT lit.

Notes:

1. Lifting the handset on some 5224 IP phones while it is in headset mode also answers the call.
2. This feature is available on some versions of the 5224 IP phone only.
3. Disconnecting the headset while in a call puts your phone in speaker-phone, mute mode. You can hear the other party but they cannot hear you. To talk to the other party, press  (**MUTE**). To hang up, press  (**SPEAKER**).

Music

To turn Music on and off when the phone is idle, do one of the following:

1. Press the Music feature key.
2. On a 5224 IP Phone, press  (**SUPERKEY**), followed by the **No** softkey until "Music?" appears, then press the **TurnOn** or **TurnOff** softkey. Press  (**SUPERKEY**).

Park and Page

With Park and Page, you can park a call and initiate a page all in one step. Park and Page options include

- **Park and Page Set:** After a call is parked, the system performs an all-set page.
- **Park and Page Group:** After a call is parked, the system pages your Paging Group.
- **Park and Page:** After a call is parked, you must enter the extension or Page Group number.
- **Park and PA Page:** After a call is parked, the you must enter a Paging Zone number (0-9).

See "Programming a Feature Key" for information on assigning this feature to a Personal Key.

To park a call and page a call:

1. Answer or make a call.
2. Perform one of the following:
 - To page all phones and the PA, press **Park & Page Sets**.
-OR-
Press **TRANS/CONF**, dial *63 and dial *.
 - To page all phones in a group and the PA, press **Park & Page Grp**.
-OR-
Press **TRANS/CONF**, dial *63 and press #.
 - To page an extension number, press **Park & Page** and dial the extension.
-OR-
Press **TRANS/CONF**, dial *63 and dial the extension.
 - To page all phones in a specified group and the PA, press **Park & Page** and dial the two-digit Page Group Number.
-OR-
Press **TRANS/CONF**, dial *63 and dial the two-digit Page Group Number, then #.
 - To park a call in orbit and perform a PA Page to any or all nine Paging Zones, press **Park & PA Page** and dial the Paging Zone number (0 for all zones, 1-9 for a specific zone).
-OR-
Press **TRANS/CONF**, dial *64 and dial the Paging Zone number (0 for all zones, 1-9 for a specific zone)

Note: To Park and Page call using speed call keys, press **TRANS/CONF** to get dial tone before pressing a speed call key programmed with the Park and Page access codes plus the digits for the required paging option (for example, an extension number to page a single phone or * to page all phones plus PA paging).

Record a Call

This feature uses your voice mail system to record your telephone conversations.

Note: You may be required by law to inform the other party that you are recording the conversation. For specific instructions, consult your system administrator.

To start recording while on a 2-party call:

- Press the **Record Call** key. (See *Feature Keys* for instructions on programming a **Record Call** key to your phone.)

Note: Your system may be programmed to automatically begin recording external calls when you or the other answers.

To control recording on a 5212 IP Phone, do one or all of the following:

- To stop and save a recording, press the Record Call feature key.
- To stop and erase a recording, press  **(CANCEL)**.

To control recording on a 5224 IP Phone, do one or all of the following:

- To pause recording, press the **Pause** softkey.
- To resume recording after pausing, press the **Resume** softkey.
- To stop a recording without saving it, press the **Erase** softkey or  **(CANCEL)**.
- To stop and save a recording, press the **Save** softkey.

Putting the call on hold saves the recording; taking the call off hold starts a new recording. Depending on system programming, hanging up, or pressing  **(TRANS/CONF)** or a **DSS** key, may also save the recording.

To listen to a recording:

1. Lift the handset.
2. Access your voice mailbox.
3. Follow the prompts to retrieve the recording.

Auto-Latch Microphone





To set the handsfree microphone to automatically turn on when receiving a Direct Page or Intercom call:

1. Press  (**SUPERKEY**).
2. Press # or the **No** softkey until "Auto Latch Mic?" appears.
NOTE: If your administrator has already enabled Auto-Latch Microphone on your phone, "Auto Latch Mic?" does not appear in your list of options.
3. Press * or the **Yes** softkey.
4. Do one of the following:
 - Press * or the **TurnOn** softkey.
 - Press # or the **TurnOff** softkey.





When Auto-Latch Microphone is enabled and your set is idle, the  (**MUTE**) key light flashes rapidly to notify you when an incoming page/intercom call has been established.

When Auto-Latch Microphone is enabled and you are engaged in a handset conversation, the  (**MUTE**) key light turns on solid to notify you when an incoming page/intercom call is waiting at your phone.

To respond to an Auto-Latch call while your phone is idle:

1. Begin speaking after the paging/intercom party addresses you. **Note:** The  (**MUTE**) key light flashes rapidly to indicate that the Handsfree microphone is on and that the calling party can hear you.
2. Press  (**MUTE**) if you wish to mute your handsfree conversation. The  (**MUTE**) key light turns on solid.
3. Press  (**MUTE**) again if you wish to turn mute off and return to the handsfree conversation. The  (**MUTE**) key light turns off.

To answer an Auto-Latch call while you are on a handset call with another caller:

- Press the lit (solid)  (**MUTE**) key. The handsfree microphone turns on and the  (**MUTE**) key light turns off to indicate that the paging/intercom party can hear you.
- Begin speaking after the paging/intercom party addresses you.
- Press  (**MUTE**) to alternate between handset and handsfree conversations. When you are speaking with the paging/intercom party, the  (**MUTE**) key light is off.

Reminder

To program a Reminder on a 5212 IP Phone:

1. Lift the handset.
2. Dial ***32**.
3. Set a time by entering the hour and minutes in 24-hour format. For example, entering 1415 sets a reminder for 2:15 PM.
You hear dial tone if the time is valid; reorder tone if it is invalid.



To cancel a timed reminder on a 5212 IP Phone:

1. Lift the handset.
2. Dial ***32** followed by 9999.
3. Hang up.
The reminder is cancelled.

To program a reminder on a 5224 IP Phone:

1. Press  (**SUPERKEY**).
2. Press the **No** softkey until "Timed Reminder?" appears.
3. Press the **Yes** softkey.
4. Enter the time in a 12-hour format—for example, 01:45.
5. Press either the **AM** or **PM** softkey.
6. Press the **Save** softkey.

To view, change, and/or cancel a pending Reminder on a 5224 IP Phone:

1. Press  (**SUPERKEY**).
2. Press the **No** softkey until "Timed Reminder?" appears.
3. Press the **Yes** softkey.
4. Do one of the following:
 - To change the Reminder, press the **Change** softkey, enter the new time, and press the **Save** softkey.
 - To cancel the Reminder, press the **Del** softkey.
 - Press  (**SUPERKEY**).

To acknowledge the reminder (indicated by a single ring), do one of the following:

- Lift the handset.
- Press the **Confirm** softkey (if available).

Reminder - Multiple

Note: The Reminder feature will not operate if Auto-Answer is enabled on your phone.

To set multiple reminders (up to three) on a 5212 IP Phone:

1. Lift the handset.
2. Dial ***32**.
3. Dial # followed by the number of the timer (#1, #2, or #3). To repeat the timer daily, dial *.
4. Set a time by entering the hour and minutes in 24-hour format. For example, entering 1415 sets a reminder for 2:15 PM.
You hear dial tone if the time is valid; reorder tone if it is invalid.
5. Repeat for each additional timer.



To cancel one or multiple reminders on a 5212 IP Phone:

1. Lift the handset.
2. Dial ***32** followed by 9999.
3. Do one of the following:
 - a. Dial 9999 to cancel Timed Reminder #1.
 - b. Dial # followed by the timer number (2 or 3) and 9999 to cancel a reminder other than #1.
4. Replace the handset.

To set multiple reminders (up to three) on a 5224 IP Phone only:

1. Press  (**SUPERKEY**).
2. Press the **No** softkey until "Timed Reminder?" appears.
3. Press the **Yes** softkey.
4. Enter the time for Timer 1 in 12-hour format—for example, 01:45. Press either the AM or PM softkey.
5. Press the Save softkey.
6. Press the Yes or **No** softkey depending on whether you want the reminder to repeat daily.
7. Repeat the first three steps, and then press the Next softkey to set Timer 2.
8. Repeat the procedure for Timer 3.

To view, change, and/or cancel a pending Reminder on a 5224 IP Phone only:

1. Press  (**SUPERKEY**).
2. Press the **No** softkey until "Timed Reminder?" appears.
3. Press the **Yes** softkey.
The reminder time for TIMER 1 appears (an asterisk beside the time indicates that the timer repeats daily, HH:MM indicates that the timer has not been programmed).
4. Press the **Next** softkey to display the other timers.
5. Do one of the following:
 - To change the time, press the **Change** softkey, enter the new time, press the **Save** softkey and then press the **Yes** or **No** softkey depending on whether you want the reminder to repeat daily.
 - To cancel the Reminder, press the **Del** softkey.
 - To exit without canceling the Reminder, press  (**SUPERKEY**).

To acknowledge the reminder (indicated by a single ring), do one of the following:

- Lift the handset.
- Press the **Confirm** softkey (if available).

Call Logging (5224 IP Phone only)

Call Logging keeps track of the names (if available) and telephone numbers of all your incoming calls or only those you missed.

To program your phone to log your incoming calls:

1. Press  (**SUPERKEY**).
2. Press the **No** softkey until "Call Logging" appears.
3. Press the **Yes** softkey.
4. Press the **Missed** softkey to log missed calls only or the **All** softkey to log all calls.
5. Press one softkey as follows:
 - Press **Intl** to log calls from other extensions only
 - Press **Extl** to log outside calls only
 - Press **Both** to log internal and external calls.

To turn off call logging:

1. Press  (**SUPERKEY**).
2. Press the **No** softkey until "Call Logging" appears.
3. Press the **Yes** softkey.
4. Press the **Off** softkey.

To display the call log:

1. Press the **Callers** feature key.
2. Press the **New** softkey to display details for newly logged calls only, or the **Old** softkey to display details for previously logged calls. The display shows the caller's number. Press the **Name** or **Num** softkey to display the caller's name or number.
3. If more than one call is logged, use the **Next** and **Previous** softkeys to display the others.

To return a call in the call log:

1. Display the call you want to return.
2. DO one of the following:
 - If the call is internal, press the **Call** softkey.
 - If the call is external, dial 9 and then press the **Call** softkey.
 - If the call is long distance, dial 91 and then press the **Call** softkey. You can dial up to three digits before pressing Call.

To delete calls from the call log:

1. Display the call you want to delete.
2. Press the **Yes** softkey to delete the displayed call only or the **All** softkey to delete all other New or Old calls.
3. Press the Confirm softkey to validate your request.

Phonebook

To access the Phonebook, do one of the following:

- On a 5224 IP Phone, press  (**SUPERKEY**) and then press the **Yes** softkey when "Phonebook?" appears.
- On a 5212 IP Phone, dial *65.

To use the Phonebook:

1. Enter the name of the person you wish to call, as follows:
 - For each letter in the name, press the appropriate key on the keypad until the letter is shown in the display. For example, if the letter C is required, press the digit 2 three times.
 - Use the # or <— softkey to correct errors.
 - If the next letter in the name is on the same digit key as the previous letter, press * or —> softkey before proceeding.
 - If required, press * or the —> softkey to add a space between the first and last name.
2. Press * or the **Lookup** softkey.
3. If no match exists, edit the original entry.
4. If more than one match is found, press # or the **Next** softkey.
5. Do one of the following:
 - To make the call, press * or the **Call** softkey.
 - To edit the entry, press # or the **Retry** softkey.
6. To exit, press  (**SUPERKEY**).

Note: Only extensions that have a voice mailbox can be dialed using Phonebook.

Call Monitoring

This feature allows you to monitor another extension user's phone conversation, either with or without the user's knowledge.

If your system is programmed to notify users that they are being monitored, they hear a beep when monitoring begins. Users that have a display telephone also see your name and extension number in the display for the duration of the call.

When monitoring a call, you can listen to the conversation but you can't speak to either party, and they can't hear you. However, you can join the conversation by forming a three-party conference

A few conditions:

- The system may be programmed to disallow monitoring of any or all extensions.
- A user can only be monitored from one extension at a time. If you try to monitor someone who is already being monitored, you receive busy tone and BUSY appears in your display.
- If the user puts the caller on hold, transfers the call, or ends the call, you are disconnected and your monitoring session ends. Note that the system can be programmed to allow monitoring to continue while the call is on hold.
- While you are monitoring, you can't make or receive calls. Anyone who calls your telephone while you are monitoring receives busy tone. The caller can leave a callback, but is unable to camp on or override your monitoring session. If you want to place an outgoing call, you must first cancel your monitoring session.

To monitor a call:

1. Lift the handset.
2. Dial ***45** followed by the number of the extension you wish to monitor.
If the user is on a call, **INTRUDING** followed by the user's extension number appears in your telephone display.
If the user is not on the phone, you hear busy tone and the user's extension number followed by the words **IS IDLE** are shown in your telephone display.
3. Do one of the following:
 - a. Press  **(TRANS/CONF)** to form a three-party conference with the user and the other party.
Press **#** or the **Exit** softkey to end the monitoring session.
NOTE: If you wish to continue monitoring after exiting the conference, you must set up the monitor again.

Door Opener

Door Opener allows you to operate a third-party door opener. For example, when someone requires entry into a third-party building, a designated extension (or extensions) rings and on answering, the extension user can press a feature key or dial a feature access code to open the door.

To use Door Opener:

- Press Door Opener feature key or dial ***66**.

Night Answer

Office telephone systems are often placed into Night Answer after regular hours. Calls then ring alternate answer points—either designated extensions or a night bell. You can dial the Trunk Answer From Any Station (TAFAS) code to answer calls ringing the night bell. If permitted by system programming, you can put your phone into one of two night answer modes, Night1 or Night2.



To switch your 5212 IP phone to Night Answer or back to Day service:

1. Lift the handset.
2. Press the Night Answer feature key. See "Feature Key" for instructions on programming a feature key.
3. Do one of the following:
 - Press 0 for Day service.
 - Press 1 for Night1.
 - Press 2 for Night2.

4. Hang up.

The Night Answer feature key light flashes slowly for Night1, and rapidly for Night2. The Night Answer feature key light is off for when your phone is in Day service.

To switch your 5224 IP Phone to Night Answer or Day service, or to view which service your phone is currently in:

1. Press  (**SUPERKEY**).
2. Press the **No** softkey until "Night Answer?" appears.
3. Press the **Yes** softkey.
4. Do one of the following:
 - To exit without making any changes, press  (**SUPERKEY**).
 - To change the mode of service, press the **Change** softkey, followed by **No** until the desired alternative appears, and then press **Yes**.

Date and Time Setup (5224 IP Phone only)

You can change the time and date that appears on all telephones equipped with displays. The time can be displayed in either a 12- or 24-hour format, depending on system programming.

To set the time:

1. Press  (**SUPERKEY**).
2. Press the **No** softkey repeatedly until "Time?" appears on the display.
3. Enter the time in the correct format.
4. Press the AM or PM softkeys (if necessary).
5. Press the Save softkey.

To set the date:

1. Press  (**SUPERKEY**).
2. Press the **No** softkey repeatedly until "Date?" appears on the display.
3. Press the **Yes** softkey.
4. Enter the date in the indicated format.
5. Press the Save softkey.

Release

Release lets you disconnect from an attempted Call Transfer or Conference Call without hanging up the handset. Release is useful when you encounter a busy or unavailable party.

To release from an attempted transfer or conference call:

- Press the Release feature key or the **Release** softkey.

Secure Hot Swap

Secure Hot Swap allows you to "swap" your own phone programming when you are using any other IP phone that is enabled to support the feature. When you dial your phone's extension number and your assigned Hot Swap Personal Identification Number, the "swapped" phone immediately assumes most of your phone settings, including key programming. Any changes you make to the phone while you are logged in—for example, adding a speed dial—are saved to your personal profile.

To Hot Swap a phone (the phone must be idle):

1. Dial ***68** or the appropriate feature access code.
2. Dial the extension number of the phone you wish to swap.
3. Enter your four-digit Hot Swap Personal Identification Number (PIN).

To verify that the phone has been swapped:

1. Press  (**SUPERKEY**).
2. Press the Prime Line key. If the phone is successfully swapped, the display shows the extension of the phone whose settings you wished to swap.

To log out of the Swapped phone (the phone must be idle):

- Dial ***68** on the phone on which you initiated the Hot Swap.

Note: Your profile can only be active on one phone at a time. You must "unswap" from the current swapped phone before you can initiate a Hot Swap of another phone.

Mobile Extension

Mitel Mobile Extension is a software solution that enables you to twin your desk phone with an external PSTN-connected phone (your cell phone, for example). Calls arriving at the desk phone ring the cell phone simultaneously, until one or the other is answered, or if unanswered, are forwarded to voice mail. For information about configuring Mobile Extension on your Mitel IP device, refer to the *Mobile Extension Quick Reference Guide* available at www.mitel.com or contact your Administrator.

USING THE LINE INTERFACE MODULE (5224 IP PHONE ONLY)

The Line Interface Module allows you to make and receive calls over an analog line (referred to as the Line Interface Module line) connected to your phone, and operates in either of the following two modes (as determined by your System Administrator):

- Line Interface Module mode, where your phone allows you to use the Line Interface Module line at any time.
- Failover Mode, where you can use the Line Interface Module line only when the IP connection has failed.

Note: Handsfree and on-hook dialing are not supported on the Line Interface Module line.

LINE INTERFACE MODULE MODE

Make A Call

To make a call using the Line Interface Module line:

1. Lift the handset.
2. Press the Line Interface Module key. ANALOG CALL appears on the display.
3. Dial the number to make the call.

Notes:

- When making external calls over the Line Interface Module line, a prefix (e.g. 9) is not required.
- If your phone's Line Interface Module key has the Privacy option enabled and another phone is on a call using the Line Interface Module line (that is, the Line Interface Module key is solid orange), you cannot access the Line Interface Module line. The user of the other phone must first hang up before you can access the Line Interface Module line. To determine whether the Privacy option is enabled, contact your System Administrator.

Answer A Call

To answer a call using the Line Interface Module line:

1. Lift the handset.
2. Press the flashing Line Interface Module key. ANALOG CALL appears on the display.

Answer a Waiting Call on the Line Interface Module Line

If you have subscribed to an analog call waiting service, you may use the hookswitch or press **ⓧ (CANCEL)** to answer a waiting Line Interface Module call. When you are on a Line Interface Module call and a waiting Line Interface Module call arrives, you will hear a beep.

Note: This feature may not be supported in all regions.

To answer a waiting Line Interface Module call, or to return to the original Line Interface Module call, do one of the following:

- Press and release the hookswitch.
- Press **⊗ (CANCEL)**.
- Press the Line Interface Module key.

Hold a Call

To put a current call on hold to answer an incoming Line Interface Module call:

- Press the flashing Line Interface Module key. The current call is put on hold.

To switch between the current call and the held call when one of the calls is using the Line Interface Module line, do one of the following:

- If your current call is using the Line Interface Module line, press the flashing Line key of the held call. The Line Interface Module call is automatically put on hold.
- If your current call is using an IP line, press the flashing Line Interface Module key. The IP line is automatically put on hold.

End a Call

To end a current call when an incoming Line Interface Module call arrives:

- Press **⊗ (CANCEL)**, and then press the flashing Line Interface Module key. The current call ends, and you are connected to the caller on the Line Interface Module line.

To end the current Line Interface Module call when an incoming call arrives:

- Press **⊗ (CANCEL)**. The current Line Interface Module call ends, and you are connected to the new caller.

FAILOVER MODE

Make A Call

To make a call using the Line Interface Module line during an IP connection failure:

1. Lift the handset. IP FAIL: ANALOG CALL appears on the display.
2. Dial the number to make the call.

Answer A Call

To answer a call using the Line Interface Module line during an IP connection failure:

- Lift the handset. IP FAIL: ANALOG CALL appears on the display, and the call is answered.

EMERGENCY CALLS

WARNING FOR EMERGENCY NUMBER DIALING: Consult your local authorities for Emergency Numbers and 911 or equivalent service availability in your area. Emergency Number dialing should only be performed by picking up the handset and selecting the Line Interface Module key. If Privacy Mode is enabled and the Line Interface Module key local line is busy, dialing will not occur on the Line Interface Module line. Emergency dialing using an IP connection may not be supported due to ICP system configuration and country location. For more information, contact your System Administrator. You can make an Emergency Call to your Local Emergency Service using the Line Interface Module line when the IP connection has failed.

To make an Emergency Call using the Line Interface Module line:

1. Lift the handset.
2. Press the Line Interface Module key.
3. Dial your Local Emergency Number. ANALOG CALL appears on the display.

FEATURE ACCESS CODES

| | |
|-----------------------------------|-----|
| Program Feature Key | *47 |
| Direct Paging | *48 |
| Retrieve Personal Speed Call | *52 |
| Store Personal Speed Call | *51 |
| Call Hold Retrieve (Remote) | *23 |
| Call Forwarding - Cancel I'm Here | *07 |
| Call Park | *33 |
| Call Hold Retrieve (Local) | *22 |
| Call Park Orbit Retrieve | *57 |
| Call Park Remote | *62 |
| Directed Call Pickup | *09 |
| Paging Access To Specific Zones | *13 |
| Group Page Meet-Me-Answer | *49 |
| Call Park and Page - Telephone | *63 |
| Call Park and Page - PA | *64 |
| Automatic Wakeup/Reminder | *32 |
| Phonebook | *65 |
| Silent Monitoring | *45 |
| Open Door | *66 |
| Secure Hot Swap | *68 |



™, © Trademark of Mitel Networks Corporation.
© Copyright 2004, Mitel Networks Corporation.
All rights reserved.